

SINGER

246-4

Form 20420
(1149)
Printed in U. S. A.

LIST OF PARTS



MACHINE No. 246-4

** A TRADE MARK OF
THE SINGER MANUFACTURING COMPANY

INSTRUCTIONS FOR OILING

To ensure easy running and prevent unnecessary wear of the parts which are in movable contact, the machine requires oiling. Check the oil gauge daily before starting the machine and maintain the oil level at the midpoint of the gauge. To oil the machine, apply "TYPE A" OIL, sold only by Singer Sewing Machine Company, to the filler cup on top of the machine, as instructed in Form 20250.

INDEX

	Page
Accessories.....	20
Belt Guard (Adjustable).....	21
Blind Stitch Hemming Attachment (flip-up type).....	21
Blind Stitch Hemming Attachment (yielding type).....	22
Blind Stitch Hemming Attachment (latch type).....	22
Chip Chute.....	23
Edge Guide (Floating).....	23
Fittings.....	23 & 20
Foot Lifter Parts.....	23
Machine Base.....	24
Machine No. 246-4.....	7
Numerical List of Parts.....	27
Thread Unwinder.....	24

INSTRUCTIONS FOR ORDERING

In ordering from this list, use ONLY the part NUMBER in the FIRST Column.

The number stamped on a Sewing Machine Part is in every case the number of the single part only.

Every combination of parts sent out as such has its specific number, which, although not stamped on the parts, must be used when ordering the combination.

Each number always indicates the SAME PART in whatever list it appears, or for whatever machine.

The letters after some of the numbers indicate the style of finish only, as follows:

- A-Hardened, Polished, Nickel Plated and Buffed.
- A.A-Buffed and Chromium Plated.
- A.B-Hardened, Polished, Buffed and Chromium Plated.
- A.C-Brown Baking Enamel Finish.
- A.D-Gray Baking Enamel Finish.
- A.E-Hardened, Bright Rumbled and Nickel Plated.
- A.F-Hardened, Bright Rumbled, Nickel Plated, Bright Rumbled and Chromium Plated.
- A.G-Alumilite, Plain.
- A.H-Alumilite Dyed.
- A.J-Polished, Nickel Plated and Chromium Plated.
- A.K-Hardened, Polished, Nickel Plated and Chromium Plated.
- A.L-Heat Treated for Toughness.
- B-Polished, Nickel Plated and Buffed.
- C-Hardened only.
- C.R-Hardened and Merlized.
- D-Polished Only.
- E-Soft, Not Polished.
- F-Hardened and Polished.
- F.J-Hardened, Polished and Nickel Plated.
- G-Bright Rumbled and Nickel Plated.
- H-Blued.
- J-Nickel Plated Only.
- K-Hardened and Nickel Plated.
- L-Brass Plated.
- M-Oxidized.
- N-Japanned, Dull.

INSTRUCTIONS FOR ORDERING - Continued

- P-Japanned, Bright.
- P.P-Wrinkle Finish.
- R-Merlized.
- S-Cadmium Plated.
- T-Copper Plated.
- T.A-Hardened, Polished, Copper and Nickel Plated and Buffed.
- T.B-Copper and Nickel Plated and Polished.
- T.J-Copper and Nickel Plated Only.
- T.K-Hardened, Copper and Nickel Plated.
- T.L-Copper and Brass Plated.
- T.M-Copper Plated and Oxidized.
- U-Zinc Plated.
- V-Silver Plated.
- W-Polished and Nickel Plated.
- X-Black Oxide, for Iron and Steel.
- X.C-Hardened and Black Oxide, for Iron and Steel.
- Y-Black Nickel Plated Only.
- Z-Chromium Plated.
- Z.A-Hardened, Polished, Nickel Plated, Buffed and Chromium Plated.
- Z.B-Polished, Nickel Plated, Buffed and Chromium Plated.
- Z.C-Hardened and Chromium Plated.
- Z.D-Polished and Chromium Plated.
- Z.G-Bright Rumbled, Nickel Plated, Bright Rumbled and Chromium Plated.
- Z.J-Nickel and Chromium Plated.
- Z.T-Copper and Chromium Plated.

These letters MUST BE USED when they appear in the list; and AFTER the number as in the list.

In this series:

I to 1500, 50001 to 51500 and 140001 to 142000 are Screw Numbers.

1501 to 1800 and 51501 to 51800 are Nut Numbers.

1801 to 2000 and 51801 to 52000 are Roller Numbers.

2001 to 50000 and 52001 to 140000 and 142001 to 190000 are Sewing Machine Parts, 190001 and upward are numbers of Electrical Parts.

The figures in the second column refer only to the plates, illustrating the parts, and are NOT TO BE USED in ordering.

Parts marked with an asterisk (*) are furnished only when repairs are made at factory.

LIST OF PARTS COMPLETE

FOR

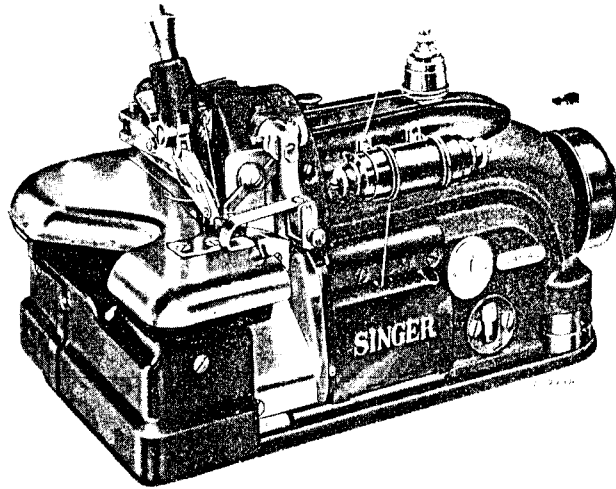

MACHINE No. 246-4

FOR TRIMMING OVEREDGING AND BLIND STITCH
HEMMING OR WELTING, RAYON, KNIT GOODS ETC.

ONE NEEDLE, ONE LOOPER. TWO-THREAD OVEREDGE
STITCH. GATHERING FEED. TRIMMER.

SPEED 5500, DEPENDING ON MATERIALS USED AND OPERATIONS
PERFORMED.

No.	Plate	Name
164234	24757	Blind Stitch Hemming Attachment Ad- justing Slide (cylindrical).....
140456K	24757	Blind Stitch Hemming Attachment Ad- justing Thumb Screw.....
140457J	24757	Blind Stitch Hemming Attachment Ad- justing Thumb Screw Locking Screw.....
164235	24757	Blind Stitch Hemming Attachment Hinge Bracket.....
164236	24757	Blind Stitch Hemming Support.....
164237	24757	Blind Stitch Hemming Attachment Sup- port complete, Nos. 140456K, 140457J, 140458C, 164234, 164235, 164236 and 164238.....
164238	24757	Blind Stitch Hemming Attachment Sup- port Cap.....
1259AL	24757	Blind Stitch Hemming Attachment Sup- port Set Screw.....
140458C	24757	Blind Stitch Hemming Attachment Thumb Screw.....

No.	Plate	Name
164347	24753	Chain Cutter.....
51362AL	24753	" " Screw (2).....
164001	24751	Chip Guard.....
1209J	24751	" " Screw (lower).....
140509J	24751	" " " (upper).....
164240	24751	Cloth Plate.....
164239	24751	" " Extension.....
914J	24751	" " " Screw (2).....
164205	24751	" " Lock Spring.....
1700J	24751	" " " Nut.....
1250AL	24751	" " " Screw Stud..
164104	24751	" " Plunger.....
164105	24751	" " Spring.....
624AL	24751	" " " Set Screw.....
164106	24751	" " Position Collar with two 624AL.....
624AL	24751	Cloth Plate Position Collar Set Screw (2).....
164241	24751	Cloth Plate with Extension complete, Nos. 1700J, 164205, 164239, 164240 and two 914J.....
164003	24752	Feed Bar Hinge Pin (eccentric).....
1369C	24752	" " " Set Screw.....
164004	24752	" " Slide Block (back) (2).....
1628C	24752	" " " " Nut.....
17022	24752	" " " " " " Washer.....
164005	24752	Feed Bar Slide Block (front).....
164016	24752	" (back) Bar with 164010.....
164017	24752	" " " Connection.....
164008	24752	" " " " Bearing..
164009	24752	" " " " Hinge Screw Stud.....
1671C	24752	Feed (back) Bar Connection Hinge Screw Stud Nut.....
164010	24752	Feed (back) Bar Connection Hinge Screw Stud Nut Position Pin.....
		Feed (back) Dog complete (See Set of Fittings complete, Page No. 19 and Page No. 20
1454F	24758	Feed (back) Dog Screw.....
164020	24752	" " Eccentric.....
	Note:	Feed (back) Eccentric No. 164020 is furnished in 6 to 16, 18, 20, 22, 24, 28, 32 and 36 stitches to the inch, unless otherwise stated No. 164020 (14 stitches to the inch) is supplied reg- ularly.
164006	24752	Feed (front) Bar with 164010.....
164007	24752	" " " Connection.....
164018	24752	" " " " Bearing.
164009	24752	" " " " Hinge Screw Stud.....
1671C	24752	Feed (front) Bar Connection Hinge Screw Stud Nut.....
164010	24752	Feed (front) Bar Connection Hinge Screw Stud Nut Position Pin.....

No.	Plate	Name
164208	-----	Feed (back) and (front) Bars com- plete, Nos. 164005, 164006, 164007, 164008, 164016, 164017, 164018 and two each 1671C, 164004 and 164009.....
		Feed (front) Dog (See Set of Fit- tings complete, Page No. 19 and Page No. 20.....
1454F	24758	Feed (front) Dog Screw.....
164020	24752	" " Eccentric.....
	Note:	Feed (front) Eccentric No. 164020 is furnished in 6 to 16, 18, 20, 22, 24, 28, 32 and 36 stitches to the inch, unless otherwise stated No. 164020 (14 stitches to the inch) is supplied reg- ularly.
164398	24752	Feed Eccentric Cover.....
164399	24752	" " " Bracket.....
157C	24752	" " " " Screw..
629K	24752	" " " " Hinge Screw...
164401	24752	" " " " Latch Spring...
227J	24752	" " " " " " Screw (2).....
164023	24752	Feed Eccentric Oil Wick.....
164402	24752	Feed Eccentric Cover complete, Nos. 629K, 164023, 164398, 164399, 164401 and two 227J.....
164025	24755	Feed Lifting and Knife (movable) Ec- centric.....
164026	24753	Knife (movable) (2).....
164027	24753	" " " Clamp.....
140050C	24753	" " " " Screw.....
164028	24753	" " " Guard.....
164029	24753	" " " Holder.....
198J	24753	" " " " Screw.....
164030	24753	" " " " Bearing
164031	24753	" " " " Lever with 620AL...
164211	-----	" " " " 164031 with 132583, 164035, 164136 and 164153.....
164032	24753	Knife (movable) Lever Bearing.....
50421AL	24753	" " " " Set Screw (long).....
624AL	24753	Knife (movable) Lever Bearing Set Screw (short).....
164246	24757	Knife (movable) Lever Cover and Presser Bar (upright) Housing with 1259AL.....
50073J	24757	Knife (movable) Lever Cover and Presser Bar (upright) Housing Screw (2).....
164247	-----	Knife (movable) Lever Cover and Presser Bar (upright) Housing complete, Nos. 50060K, 164137, 164138, 164139, 164142, 164143, 164144, 164194 and 164246.....

From the Library of Distant Needle Corp.

No.	Plate	Name
164180	24753	Knife (movable) Lever Guide.....
164181	24753	" " " " Holder with two 140239AL.....
164210	24753	Knife (movable) Lever Guide Holder 164181 with 197J, 164177, 164180 and 164182.....
140239AL	24753	Knife (movable) Lever Guide Holder Set Screw (2).....
164182	24753	Knife (movable) Lever Guide Holder Thread Tube.....
50421AL	24753	Knife (movable) Lever Guide Holder Thread Tube Set Screw.....
197J	24753	Knife (movable) Lever Guide Screw...
132583	24753	" " " Hinge Pin with 132584.....
132584	24753	Knife (movable) Lever Hinge Pin Oil Wick.....
620AL	24753	Knife (movable) Lever Hinge Pin Set Screw.....
164034	24753	Knife (movable) Lever Hinge Stud....
164035	-----	" " " " " 164034 with 164036 and 164269...
164036	24753	Knife (movable) Lever Hinge Stud Oil Wick (long).....
164269	-----	Knife (movable) Lever Hinge Stud Oil Wick (short).....
50421AL	24753	Knife (movable) Lever Hinge Stud Set Screw (back).....
1143AL	24753	Knife (movable) Lever Hinge Stud Set Screw (top).....
164037	24753	Knife (stationary) (2).....
164038	24753	" " Clamping Stud....
51715AL	24753	" " " " Nut
164039	24753	" " Holder.....
164040	24753	" " Adjusting Stud.....
1454E	24753	Knife (stationary) Holder Adjusting Stud Cap Screw.....
39541	24753	Knife (stationary) Holder Adjusting Stud Cap Screw Washer.....
164041	24753	Knife (stationary) Holder Cap.....
164042	24753	" " " Sleeve....
140088R	24753	" " " " Screw.....
59456	24753	Knife (stationary) Holder Sleeve Screw Washer.....
164043	24753	Knife (stationary) Holder Spring....
164044	24753	" " " " Re- tainer.....
1454J	24753	Knife (stationary) Holder Spring Re- tainer Screw.....
164045	24754	Looper.....
164046	24754	" Carrier with 460AL, 50379F and 164202.....
164047	24754	Looper Carrier Holder with two 140393AL.....

No.	Plate	Name
164212	-----	Looper Carrier Holder 164047 with 1324C, 59456 and 164046.....
140393AL	24754	Looper Carrier Holder Set Screw (2).
1324C	24754	" " Screw.....
460AL	24754	" " " Set Screw.....
59456	24754	" " " Washer.....
164048	24754	" Driving Shaft.....
164049	24754	" " " Bushing (back).
140394E	24754	" " " " " Cap Screw.....
164293	24754	Looper Driving Shaft Bushing (back) Cap Screw Washer (fiber).....
164050	24754	Looper Driving Shaft Bushing (front)
164051	24754	" " " Crank with 1083C.....
1083C	24754	Looper Driving Shaft Crank Clamping Screw.....
164052	24755	Looper Driving Shaft Crank Connec- tion with two each 171AL and 140159AL.....
164215	-----	Looper Driving Shaft Crank 164051 with 164052.....
171AL	24755	Looper Driving Shaft Crank Connec- tion Cap (lower) Screw (2).....
140159AL	24755	Looper Driving Shaft Crank Connec- tion Cap (upper) Screw (2).....
164067	24754	Looper Driving Shaft Crank Key.....
1324C	24754	" " " " " Screw
45057	24754	" " " " " " Washer.....
164053	24754	Looper Driving Shaft Crank Thrust Bearing.....
50379F	24754	Looper Set Screw.....
164202	24754	" Stop Pin.....
164349	24758	" Thread Tube.....
853AL	24758	" " " Set Screw.....
*164072	-----	Machine Frame.....
*164073	-----	Machine Frame complete, Nos. 45773, 140396E, 164072, 164077, 164218, two 15405 and three 140395C.....
164074	24756	Machine Frame Bottom Cover.....
164075	24756	" " " " Gasket...
914C	24756	" " " " Screw (13).....
*164076	-----	Machine Frame Bracket.....
*164218	-----	" " " 164076 with 164207 and two 187E.....
164207	24759	Machine Frame Bracket Key.....
187E	24759	" " " " Screw (2).
140396E	24759	" " " " Screw (large).
164077	24759	" " " " " Washer (fiber).....
164229	24759	Machine Frame Bracket Screw (large) Washer (felt).....
140395C	24759	Machine Frame Bracket Screw (small) (3).....

In the Library of the Department of Defense

No.	Plate	Name
164078	24756	Machine Frame Cover (back).....
50571J	24756	" " " " Screw
		(long) (2).....
914J	24756	Machine Frame Cover (back) Screw
		(short).....
164079	24756	Machine Frame Cover (back) Slide....
140200J	24756	" " " " " Po-
		sition Screw.....
238J	24756	Machine Frame Cover (back) Slide
		Stop Screw.....
164080	24756	Machine Frame Cover (back) complete,
		Nos. 238J, 1637K, 140200J,
		140228C, 164078 and 164079.....
164081	24759	Machine Frame Oil Lead.....
140088R	24759	" " " " Screw.....
1698J	24759	" " " " Nut....
164082	24759	" " " Plug Bracket.....
1036AL	24759	" " " " Set
		Screw.....
51285E	24759	Machine Frame Oil Plug Screw.....
164313	24759	" " " " Washer
		(steel).....
164314	24759	Machine Frame Oil Plug Screw Washer
		(cork).....
164083	24759	Machine Frame Oil Screen.....
206J	24759	" " " " Screw.....
164084	24759	" " " Splash Guard (in-
		ternal).....
206J	24759	Machine Frame Oil Splash Guard (in-
		ternal) Screw (2).....
164085	24757	Machine Frame Oil Splash Guard (top)
51023W	24757	" " " " "
		Screw (2).....
164086	24759	Machine Frame Oil Tube with 164087..
50421AL	24759	" " " " Set Screw....
164087	24759	" " " " Wick.....
164088	24755	" " Plug.....
164089	24755	" " Rotary Shaft.....
164090	-----	" " " " 164089
		with 164097, 164215, 164216,
		164217 and two each 164093 and
		164232.....
139026	24755	Machine Frame Rotary Shaft Ball
		Bearing.....
164092	24755	Machine Frame Rotary Shaft Ball
		Bearing Housing.....
51369C	24755	Machine Frame Rotary Shaft Ball
		Bearing Housing Screw (3).....
164093	24755	Machine Frame Rotary Shaft Ball
		Sleeve (two pieces) (2).....
164232	24755	Machine Frame Rotary Shaft Ball
		Sleeve Guide (2).....
164094	24755	Machine Frame Rotary Shaft Bushing
		(front).....
1036AL	24755	Machine Frame Rotary Shaft Bushing
		(front) Set Screw.....

No.	Plate	Name
164095	24755	Machine Frame Rotary Shaft Bushing
		(intermediate).....
51332C	24755	Machine Frame Rotary Shaft Bushing
		(intermediate) Set Screw.....
164096	24755	Machine Frame Rotary Shaft Counter-
		balance with 1036AL.....
1036AL	24755	Machine Frame Rotary Shaft Counter-
		balance Set Screw.....
164097	24755	Machine Frame Rotary Shaft Key.....
1701C	24755	" " " " Nut.....
164098	24755	" " " " Oil Sling
		and Ball Bearing Grease Retainer
164099	24755	Machine Frame Rotary Shaft Screw
		Stud.....
164100	24755	Machine Frame Rotary Shaft Thrust
		Bearing.....
164101	24760	Machine Frame Top Cover.....
164214	-----	" " " " 164101 with
		330J, 164103 and two each 54865
		and 64666.....
164102	24760	Machine Frame Top Cover Gasket....
164103	24760	" " " " Oil Lead....
330J	24760	" " " " "
		Screw.....
51369J	24760	Machine Frame Top Cover Screw (3)...
164231	24755	" Pulley (round and "V" belt)
		with two 448AL.....
164071	24755	Machine Pulley Cap.....
140416X	24755	" " " Screw.....
448AL	24755	" " Set Screw (2).....
164109	24757	Needle Clamp.....
51720C	24757	" Clamping Nut.....
164110	24757	" Driving Shaft with 164118....
164275	-----	" " " 164110 with
		51720C, 164109 and 164117.....
164111	24757	Needle Driving Shaft Bushing.....
164112	24757	" " " " Cap....
164113	24757	" " " " Oil
		Lead.....
452C	24757	Needle Driving Shaft Bushing Oil
		Lead Hole Plug Screw.....
164114	24757	Needle Driving Shaft Crank with
		1083C and two 140393AL.....
164115	24757	Needle Driving Shaft Crank Ball....
1083C	24757	" " " " Clamping
		Screw.....
164116	24755	Needle Driving Shaft Crank Connec-
		tion with two each 171AL and
		140159AL.....
164217	-----	Needle Driving Shaft Crank Connec-
		tion 164116 with 164115.....
140159AL	24755	Needle Driving Shaft Crank Connec-
		tion Cap (lower) Screw (2).....
171AL	24755	Needle Driving Shaft Crank Connec-
		tion Cap (upper) Screw (2).....
140393AL	24757	Needle Driving Shaft Crank Set Screw
		(2).....

From the Library of Diarrhoeal Needle Corp.

No.	Plate	Name
164117	24757	Needle Holder.....
164118	24757	" " Stop Pin.....
164119	24755	Oil Agitator.....
164120	24759	" Cooler with 456C and two 164125.
164121	24759	" " Cover.....
164123	24759	" " " 164121 with 164135.
164122	24759	" " " Gasket.....
145J	24759	" " " Screw.....
164124	24759	" " Gasket.....
164125	24759	" " Oil Pipe (outlet, left)..
164125	24759	" " " " (outlet, right).
164126	24759	" " " Tube with 138269 and 164128.....
164127	24759	Oil Cooler Oil Tube Coupling.....
51630	24759	" " " " Lock Nut.....
138269	24759	" " " " Sleeve.....
164128	24759	" " " " Wick.....
456C	24759	" " Plug Screw.....
51139J	24759	" " Screw (long) (2).....
1324J	24759	" " Screw (short).....
164131	24759	" Sight Gauge Background Disc.....
164132	24759	" " " " " Gas- ket.....
164133	24759	Oil Sight Gauge Window.....
164132	24759	" " " " Gasket.....
164134	24759	" " " " Retainer.....
164132	24759	" " " " " Gas- ket.....
1485J	24759	Oil Sight Gauge Window Retainer Screw (2).....
164135	24759	Oil Cup for filling machine.....
164136	24753	Presser Bar Bracket.....
164137	24757	" " Lifting Bracket with 462AL, 624AL and 51846.....
51846	24757	Presser Bar Lifting Bracket Roller and Stud.....
624AL	24757	Presser Bar Lifting Bracket Set Screw (long).....
462AL	24757	Presser Bar Lifting Bracket Set Screw (short).....
164138	24757	Presser Bar Lifting Lever.....
164139	24757	" " " " Spring....
140228C	24756	" " " " Stop Screw
1637K	24756	" " " " " " "
164350	24753	Presser Bar (swing-out).....
164141	24753	" " " Lifting Screw Stud.....
1700J	24753	Presser Bar (swing-out) Lifting Screw Stud Nut.....
164142	24757	Presser Bar (swing-out) Opening Lever.....
50060K	24757	Presser Bar (swing-out) Opening Lever Hinge Screw.....
140510C	24753	Presser Bar (swing-out) Pivot Screw.
164351	24753	" " " " " "
		Lock Washer.....

No.	Plate	Name
51362AL	24753	Presser Bar (swing-out) Pivot Screw Lock Washer Screw.....
164143	24757	Presser Bar (upright).....
164144	24757	" " " Spring.....
*164352	-----	" Foot Body (back).....
*164353	-----	" " " (front).....
164354	24758	" " " (hinged) Nos. 164352, 164353 and 164355.....
164355	24758	Presser Foot Body Hinge Pin.....
164356	24758	" " Chaining-off Finger....
164147	24758	" " Clamping Plate.....
50225J	24758	" " " " Screw...
164357	24758	Presser Foot (hinged) complete, Nos. 50225J, 164147, 164354 and 164356.....
164194	24757	Pressure Regulating Thumb Screw....
164252	24754	Spreader.....
164056	24754	" Carrier with 50370E.....
164057	24754	" " Connection.....
164058	24754	" " " Guide Bar with 624AL and 164172.....
164172	-----	Spreader Carrier Connection Guide Bar Oil Wick.....
624AL	24754	Spreader Carrier Connection Guide Bar Plug Screw.....
164059	24754	Spreader Carrier Connection Guide Bar Bracket with 164060 and two 462AL.....
164060	24754	Spreader Carrier Connection Guide Bar Bracket Oil Pad.....
914C	24754	Spreader Carrier Connection Guide Bar Bracket Screw (left).....
1057AL	24754	Spreader Carrier Connection Guide Bar Bracket Screw (right).....
462AL	24754	Spreader Carrier Connection Guide Bar Set Screw (2).....
164061	24754	Spreader Carrier Connection Hinge Stud with 1019AL.....
1443J	24754	Spreader Carrier Connection Hinge Stud Cap Screw.....
164397	24754	Spreader Carrier Connection Hinge Stud Adjusting Pin.....
1019AL	24754	Spreader Carrier Connection Hinge Stud Adjusting Pin Set Screw....
132565	24754	Spreader Carrier Hinge Pin.....
50370E	24754	" " " " Set Screw
164062	24754	" Driving Lever with 1083C and two 140593AL.....
1083C	24754	Spreader Driving Lever Clamping Screw.....
164213	-----	Spreader Driving Lever 164062 with 1443J, 1700J, 132565, 164056, 164057, 164058, 164059, 164061, 164068 and 164397.....
140393AL	24754	Spreader Driving Lever Set Screw (2)
164063	24754	" " Shaft.....

No.	Plate	Name
1094F	24758	Throat Plate Screw (2).....
*45773	-----	Trade Mark.....
15405	-----	" " Rivet (2).....

SINGER Needles should be used
in **SINGER** Machines
These Needles and their Containers
are marked with the
Company's Trade Mark "SIMANCO.***" 1

Needles in Containers marked
"FOR SINGER MACHINES"
are NOT **SINGER** made needles. 2

FITTINGS

SET OF FITTINGS COMPLETE, No. 164382

For Rayon, Balbriggan and Nylon

For Two-thread Blind Hem Stitch

No.	Plate	Name
164347	24765	Chain Cutter.....
51362AL	24765	" " Screw (2).....
164363	24765	Feed (back) Dog Section (left).....
164243	24765	" " " " (right).....
1100AL	24765	" " " " " " Screw.....
164364	24765	Feed (back) Dog complete, Nos. 1100AL, 164243 and 164363.....
164365	24765	Feed (front) Dog.....
164026	24765	Knife (movable).....
164037	24765	" (stationary).....
164045	24765	Looper.....
164350	24765	Presser Bar (swing-out).....
*164352	-----	" Foot Body (back).....
*164353	-----	" " " (front).....
164354	24765	" " " (hinged) Nos. 164352, 164353 and 164355.....
164355	24765	Presser Foot Body Hinge Pin.....
164356	24765	" " Chaining-off Flinger....
164147	24765	" " Clamping Plate.....
50225J	24765	" " " " Screw....
164357	24765	Presser Foot (hinged) complete Nos. 50225J, 164147, 164354 and 164356.....
164252	24765	Spreader.....
164091	24765	Thread (looper) Stripper and Take-up
164175	24765	" " Take-up.....
164358	24765	Throat Plate.....
164382	24765	Set of Fittings complete, Nos. 164026, 164037, 164045, 164091, 164175, 164252, 164347, 164350, 164357, 164358, 164364, 164365 and two 51362AL.....

L. from the Rayon; Diamond Needle Corp.

Blind Stitch Hemming Attachment (yielding type)

Complete, No. 160384 For Tubular Work

No.	Plate	Name
160385	24758	Folder.....
160383	24758	" " Bracket.....
160575	-----	Folder Holder complete, Nos. 3146, 50388J and 160383.....
50388J	24758	Folder Screw.....
3146	24758	" " Washer.....
160384	24758	Blind Stitch Hemming Attachment com- plete, Nos. 160385 and 160575....

Blind Stitch Hemming Attachment (latch type)

Complete, No. 160392 For Open End Work

No.	Plate	Name
160382	24758	Folder.....
160386	24758	" " Hinge.....
160387	24758	" " Bracket with 468C.....
59480	24758	" " Pin.....
468C	24758	" " Set Screw.....
160388	24758	" " Flunger.....
160389	24758	" " Spring.....
160576	-----	Folder Holder complete, Nos. 202J, 973J, 1772C, 3146, 50388J, 59480, 160386, 160387, 160388, 160390, 160391 and three 160389.
160390	24758	Folder Latch.....
160391	24758	" " Guide Bracket.....
202J	24758	" " " " Screw....
973J	24758	" " Hinge Screw.....
1772C	24758	" " " " Nut.....
160389	24758	" " Spring (2).....
50388J	24758	" Screw.....
3146	24758	" " Washer.....
160392	24758	Blind Stitch Hemming Attachment com- plete, Nos. 160382 and 160576....

CHIP CHUTE

No.	Plate	Name
168198	24763	Chip Chute with four wood screws 3/8 in. No. 6 R.H. blacked.....

EDGE GUARD (floating)

Complete, No. 160510 for Light, Medium and Heavy Work

No.	Plate	Name
160507	24758	Edge Guide (floating).....
160395	24758	" " " Spring.....
904AL	24758	" " " " Screw..
220J	24758	" " " " " Lock Screw.....
160508	24758	Edge Guide (fixed).....
240J	24758	" " " " Screw.....
160509	24758	" " Adjusting Bracket.....
208J	24758	" " " " " Screw..
50589K	24758	" " " " " Screw.....
160398	24758	" " Bracket with 220J and 904AL.....
160399	24758	Edge Guide Support and Throat Plate Guide with 853AL.....
1454E	24758	Edge Guide Support and Throat Plate Guide Screw.....
160510	24758	Edge Guide (floating) complete Nos. 208J, 240J, 50589K, 160395, 160398, 160399, 160507, 160508 and 160509.....

FOOT LIFTER PARTS

No.	Plate	Name
6439	24763	Chain, 36 in. to 45 in. with 56864 and 56865.....
Note: When ordering No. 6439, give length required.		
4879	24763	Chain Connecting Link.....
56864	24763	" Hook (large).....

Diamond Needle Corp.

FOOT LIFTER PARTS

No.	Plate	Name
56865	24763	Chain Hook (small).....
4881	24763	Treadle.....
4882	24763	" Shaft.....
4883	-----	" Spring.....
4884	24763	" Stand.....
4885	24763	Treadle complete, Nos. 4879, 4881, 4882, 4883, 4884 and two wood screws 1 in. No. 16 F.H.....

MACHINE BASE

No.	Plate	Name
164184	24763	Machine Base with 50608R, 139017 and two each wood screws 3/4 in. No. 8 R.H. and 1 1/4 in. No. 6 F.H..
50608R	24763	Machine Base Plug Screw.....
139017	24763	" " " Washer.....
164188	24763	" Cushion (large) (2).....
164189	24763	" " (small) (2).....
164190	24763	" Pad (felt).....
140418E	24755	" Screw Stud (back).....
657E	24755	" " " (front).....

THREAD UNWINDER No. 151031

For Three Spools

No.	Plate	Name
151023	24764	Spool Rest with 858AL.....
150203	24764	" " Cushion (felt) (3).....
858AL	24764	" " Hub Set Screw.....
151024	24764	" " Rod.....
1122C	24764	" " " Set Screw (2).....
151025	24764	" " Stand with two 1122C and three wood screws 1 in. No. 12 F.H.....
151026	24764	Thread Guide (lower).....
50311C	24764	" " " Holder Set Screw.....
151027	24764	Thread Guide (lower) Support with 50311C.....
151028	24764	Thread Guide (upper) (2).....

THREAD UNWINDER

No.	Plate	Name
151029	24764	Thread Guide (upper) Holder with four 453AL.....
453AL	24764	Thread Guide Set Screw (3).....
151030	24764	" " Rod.....
453AL	24764	" " " Set Screw.....
151031	24764	Thread Unwinder complete, Nos. 151023, 151024, 151025, 151026, 151027, 151029, 151030, two 151028 and three 150203.....

SINGER Needles should be used
in **SINGER** Machines
These Needles and their Containers
are marked with the
Company's Trade Mark "SIMANCO.**" 1

Needles in Containers marked
"FOR SINGER MACHINES"
are **NOT SINGER** made needles. 2

24751 - 1/2

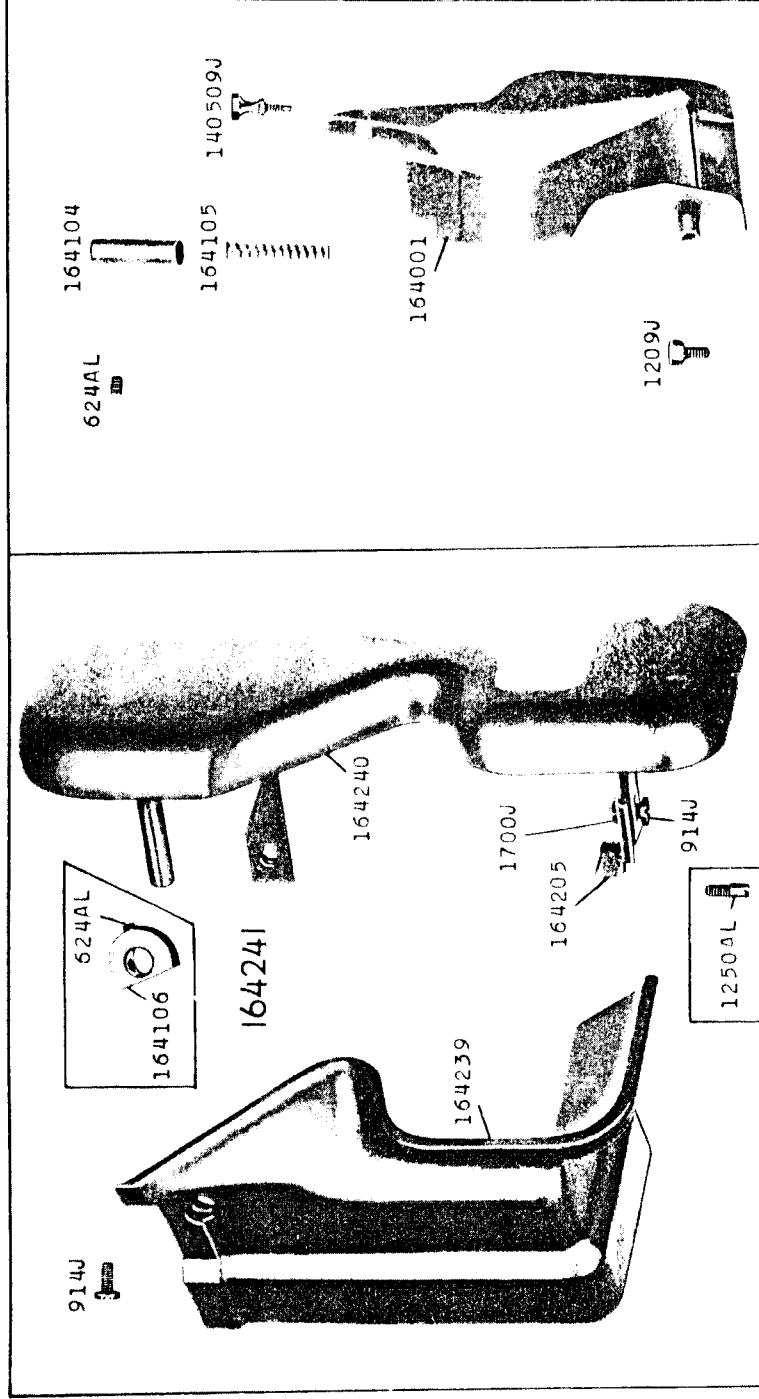

From the library of: Diamond Needle Corp

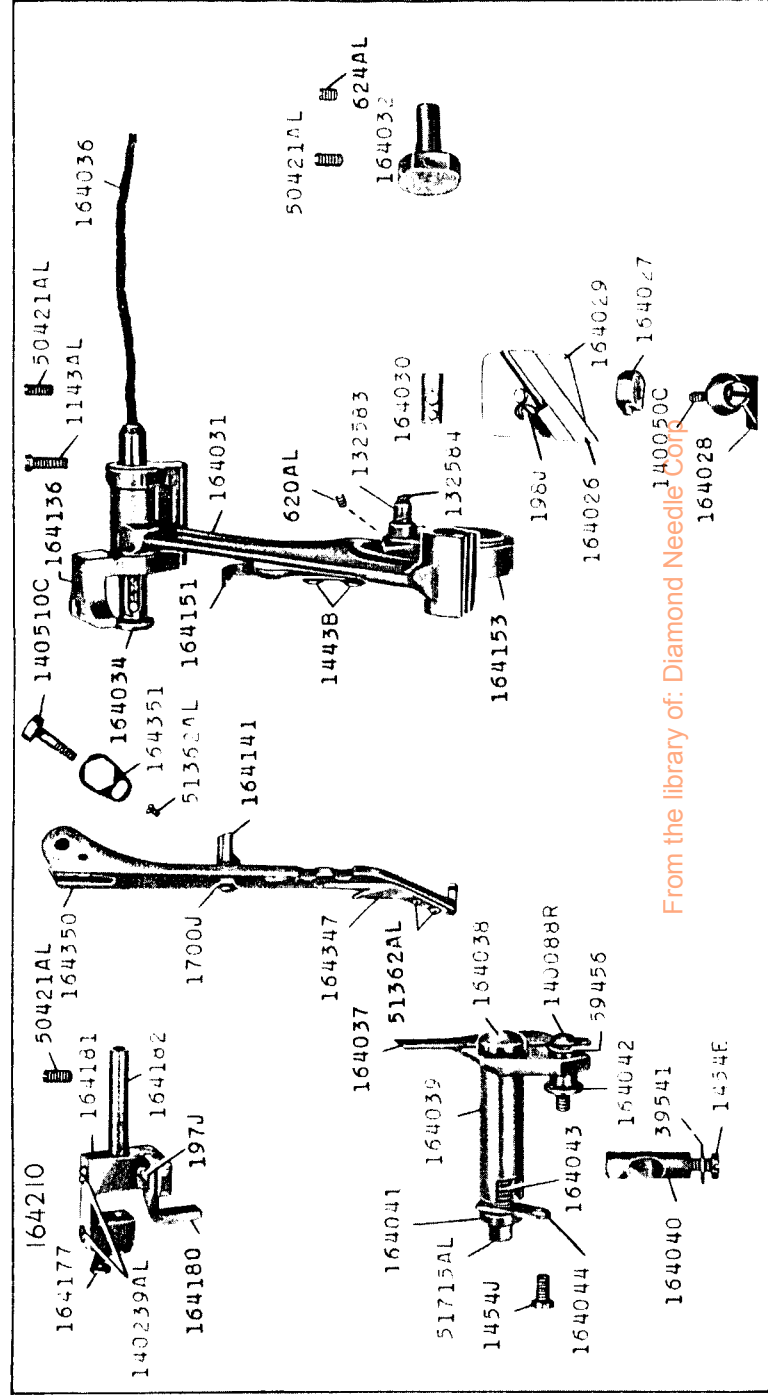
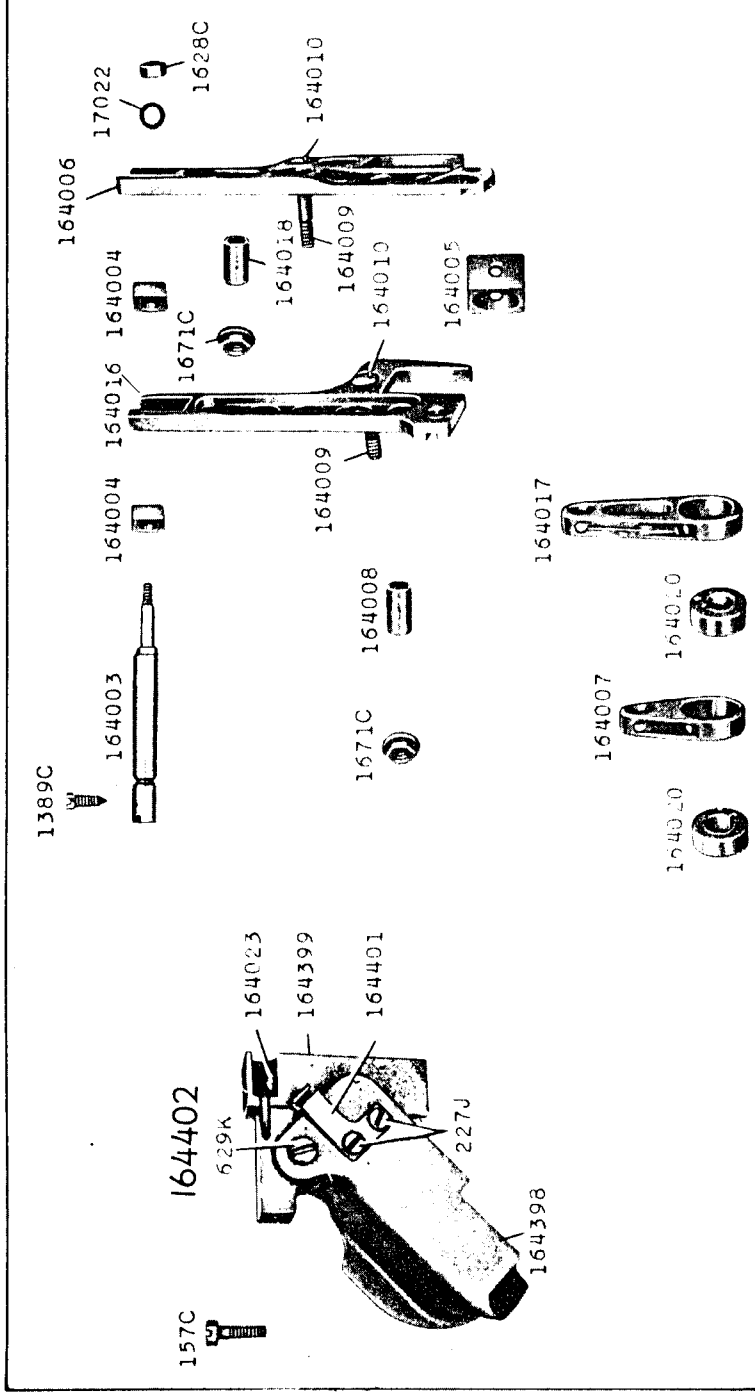

From the library of: Diamond Needle Corp

24756 - 1/3

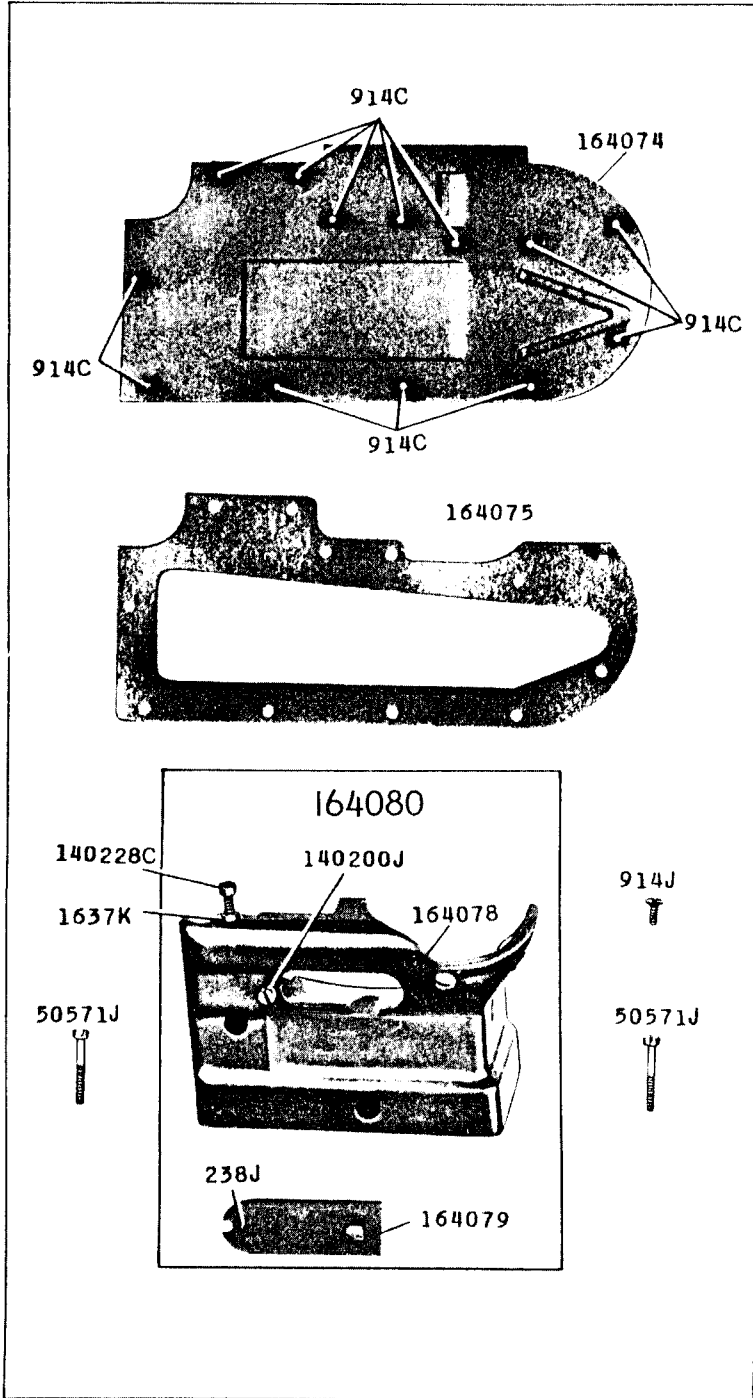

24757 - 1/2

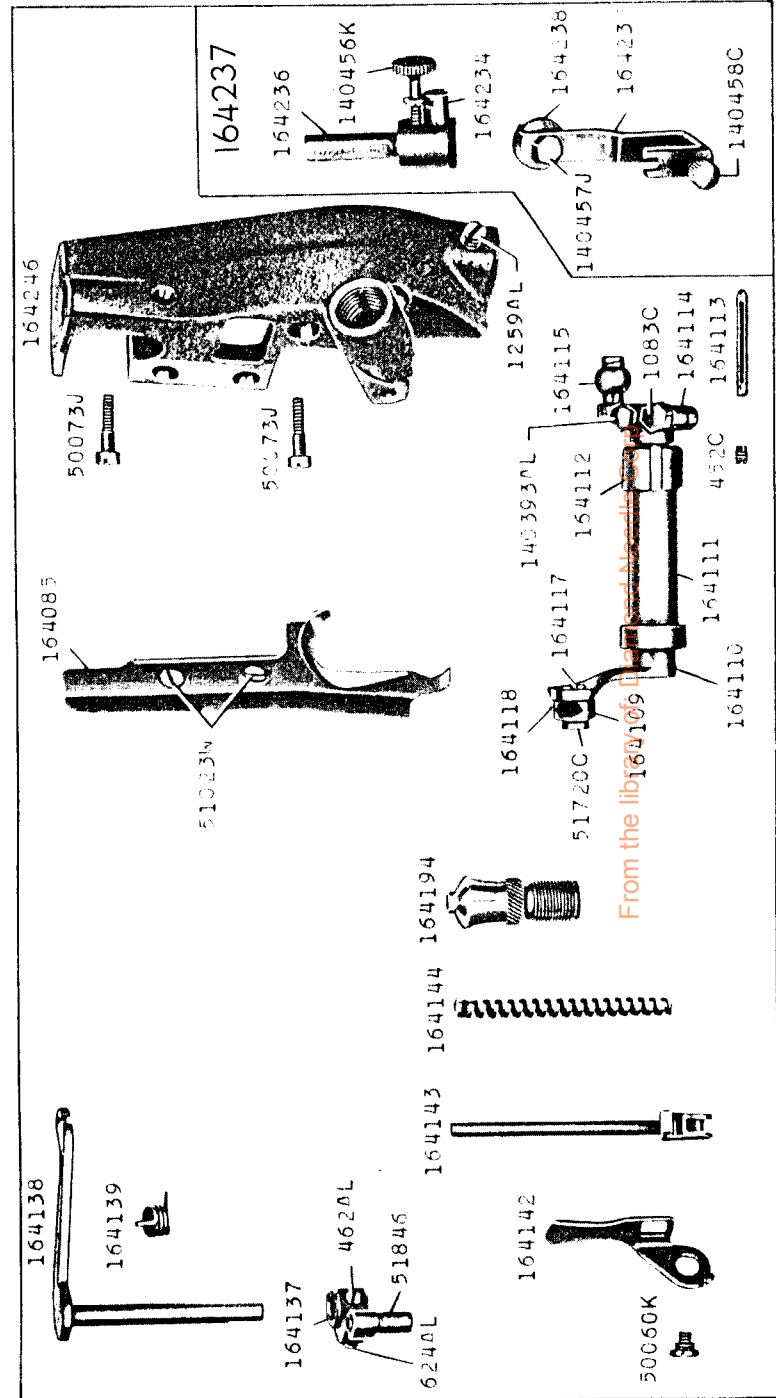

24758 - 1/2

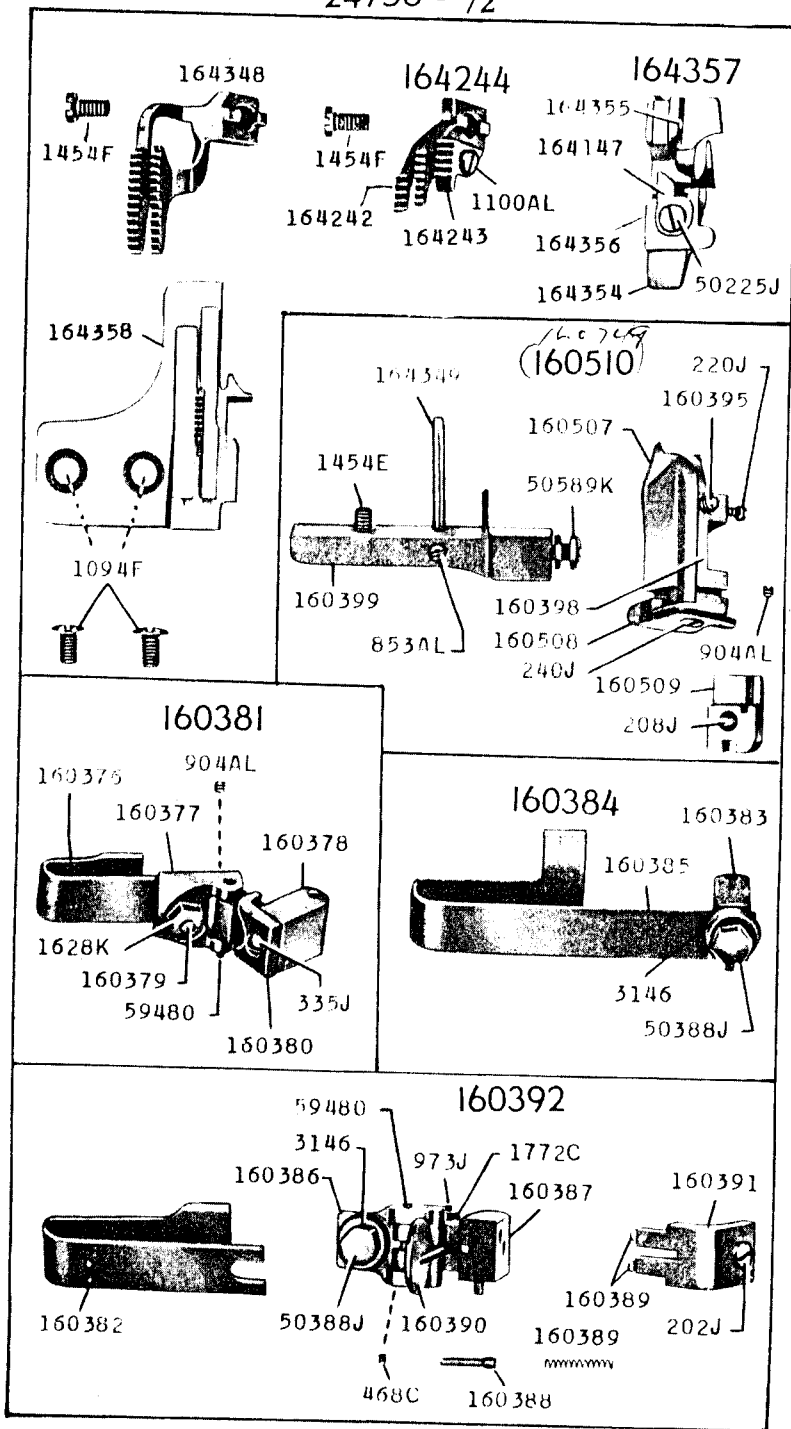

24759 - 1/3

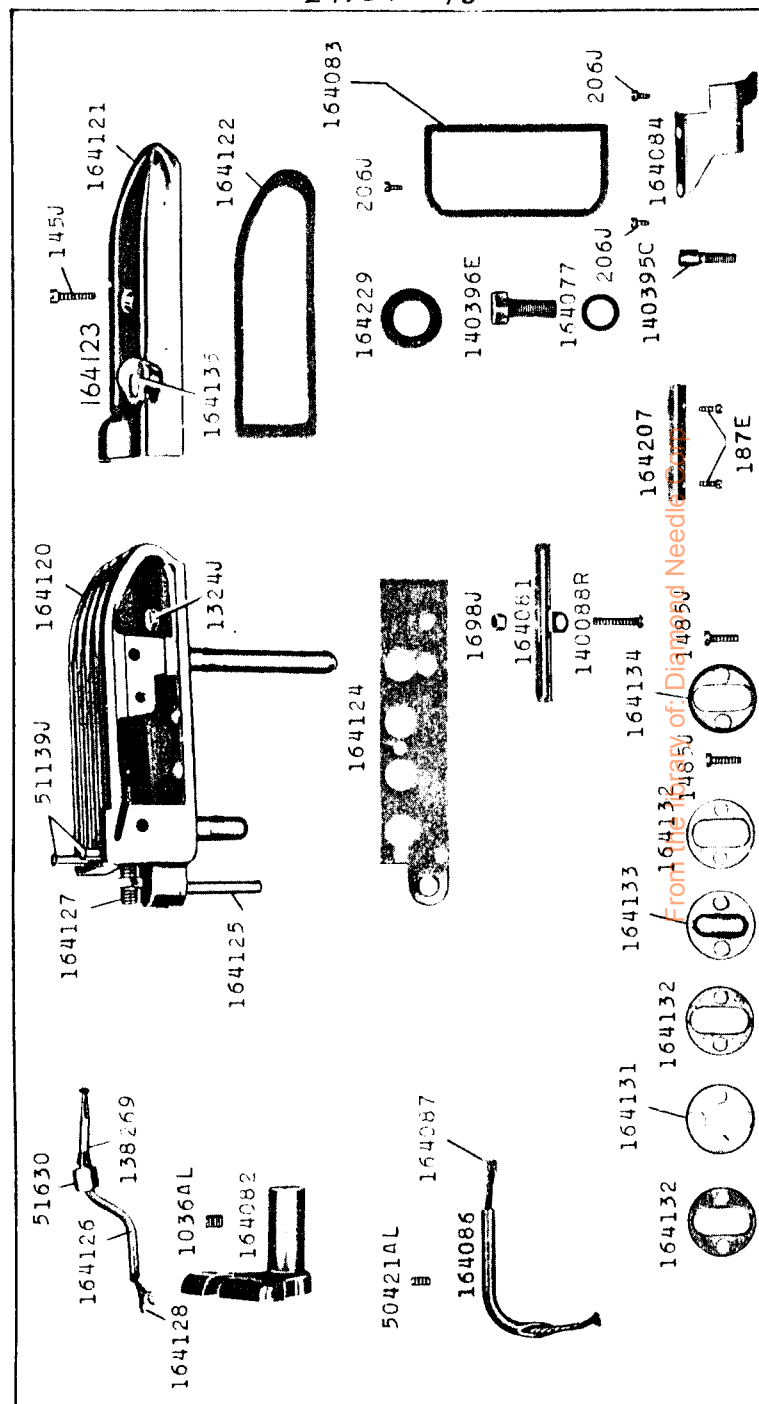

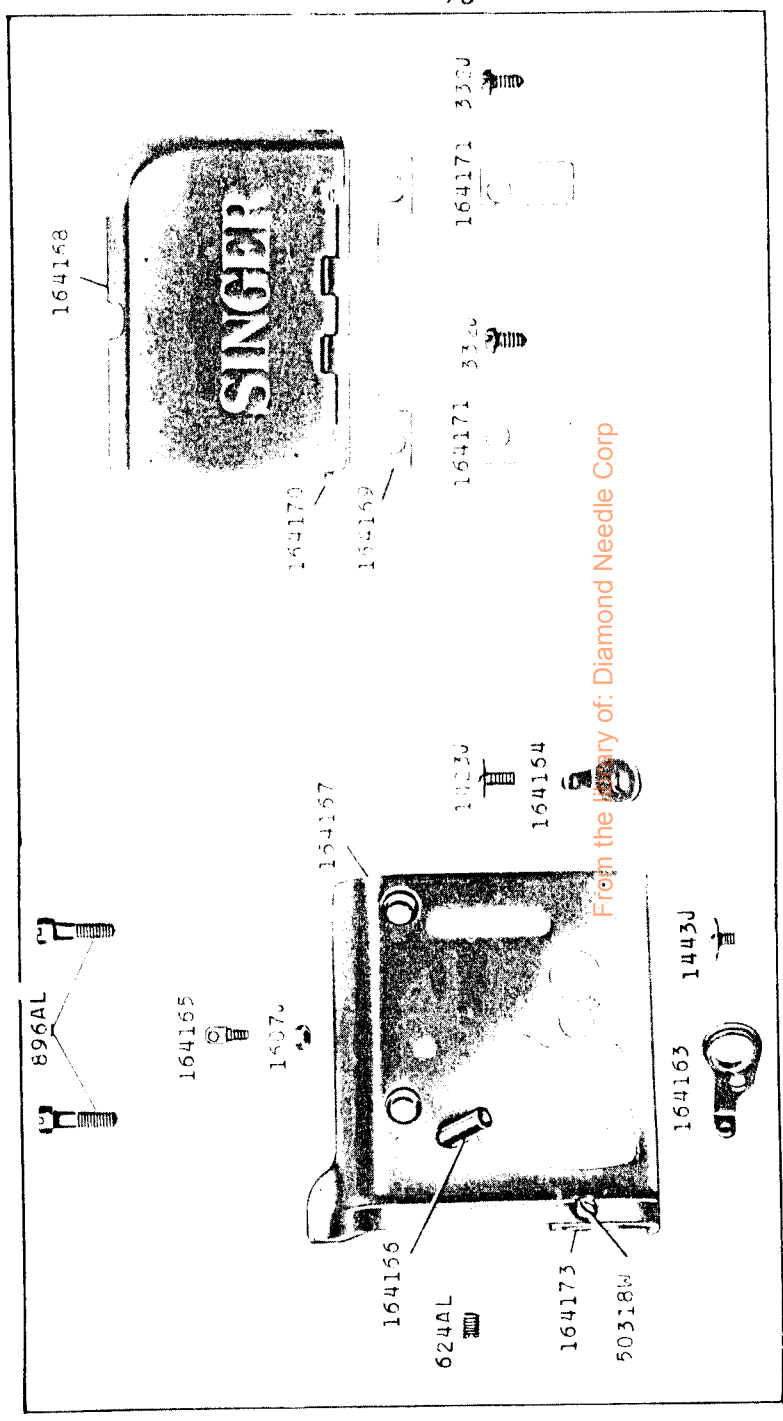
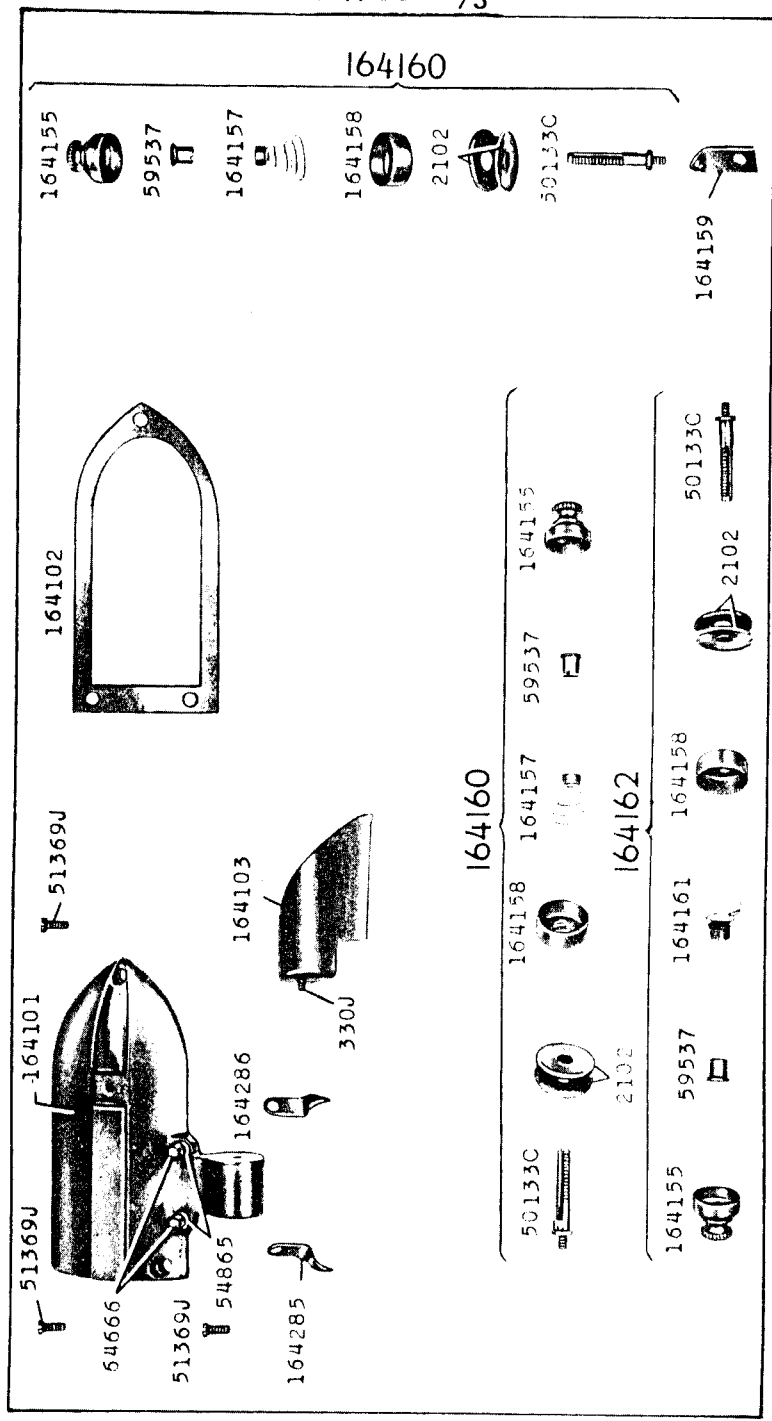

From the Library of: Diamond Needle Corp

24762 - 1/2

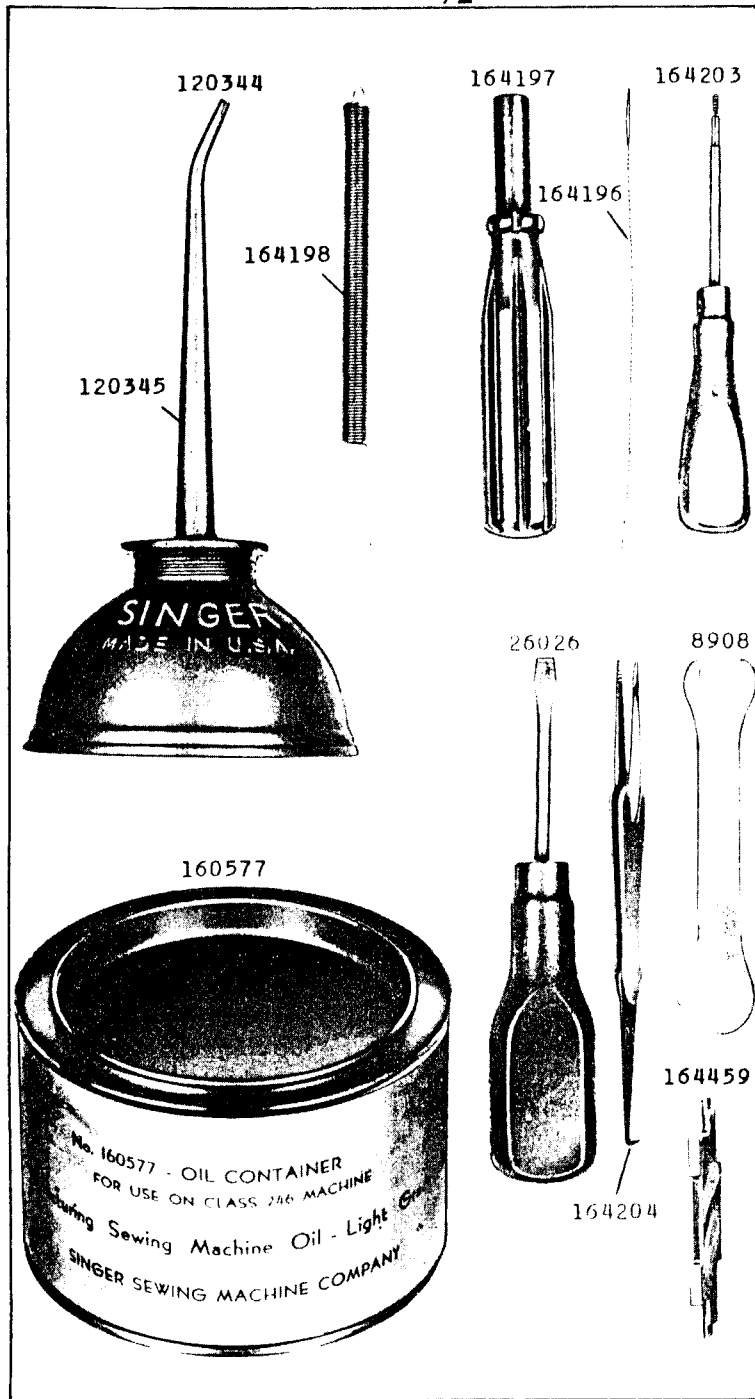

24763 - 1/4

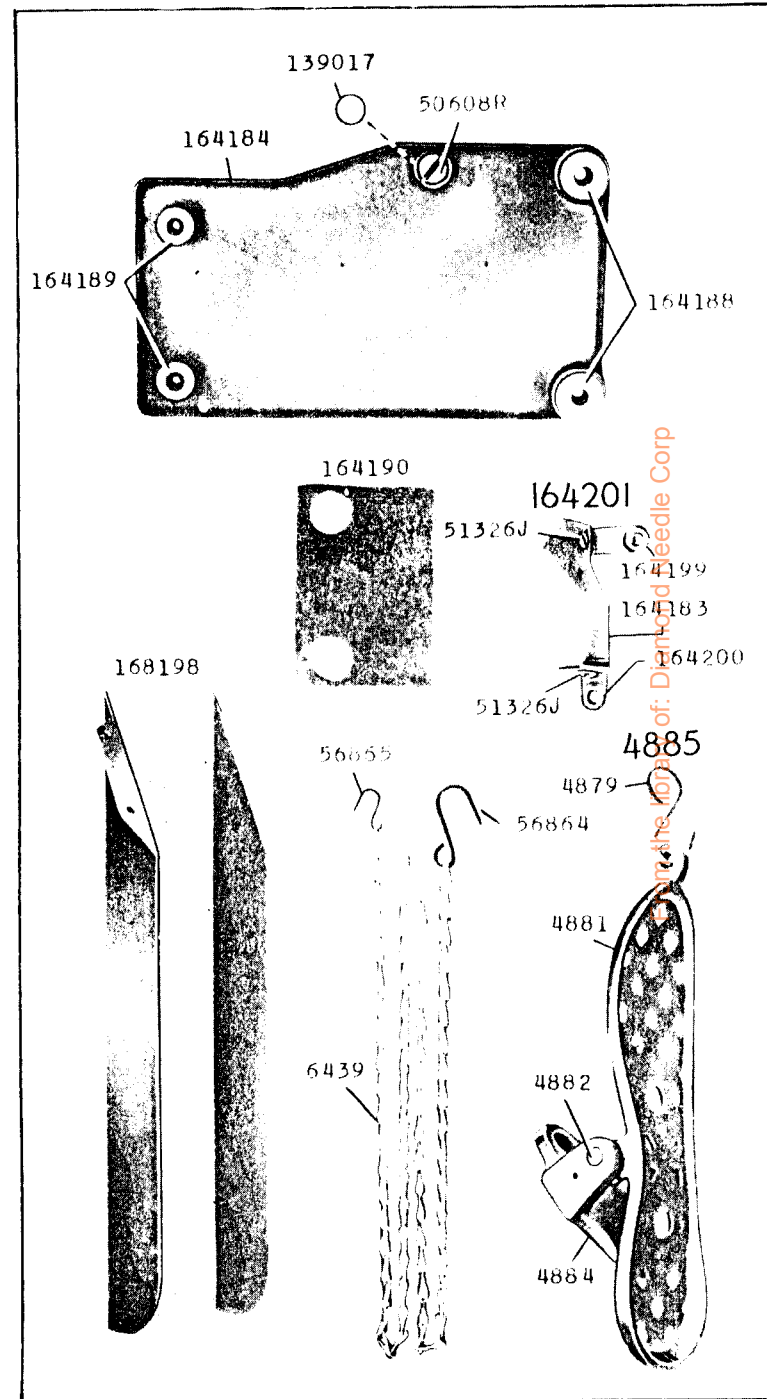

Singer's Home of Darning Needle Corp

24764 - 1/6

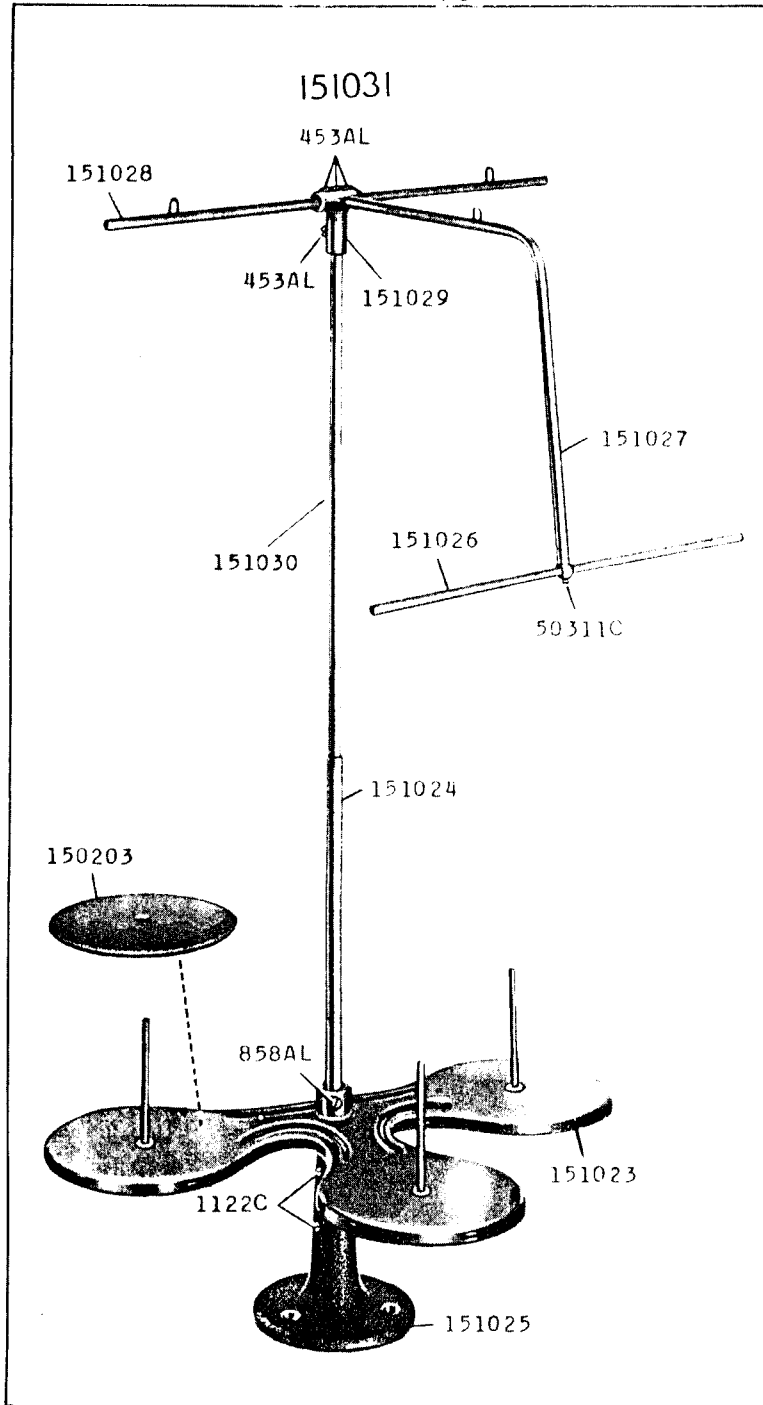

24765 - 1/2

164382

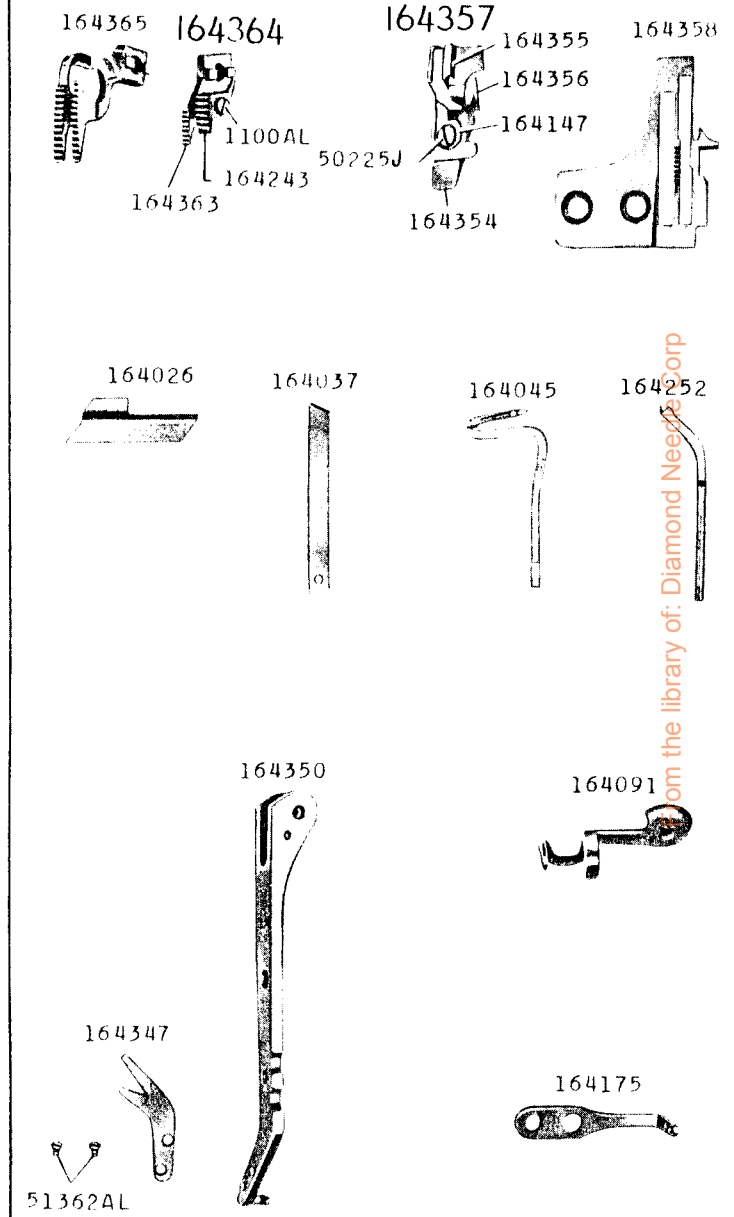

From the library of: Diamond Needs Corp

24766 - 1/2

164383

